



ResMed

Stellar™ series
Non-invasive/invasive ventilators



User Guide
English

Contents

Introduction	1
Indications for use	1
Contraindications	1
Adverse effects	1
Stellar at a glance	2
Patient interface	3
Humidification	3
Internal battery	3
ResMed USB stick	3
Use on an aircraft	4
Mobile use	4
Remote Alarm	4
Setting up for noninvasive use	4
Attaching the H4i heated humidifier for noninvasive use	5
Setting up for invasive use	5
Using the Stellar device for the first time	8
Working with other optional accessories	8
Attaching the pulse oximeter	8
Adding supplemental oxygen	8
Using the FIO ₂ monitoring sensor	10
Attaching an antibacterial filter	10
Stellar basics	11
About the control panel	11
LCD screen	12
Starting therapy	13
Performing a functional test	13
Starting therapy	14
Stopping therapy	14
Turning off the power	14
Working with alarms	15
Tailoring treatment setup options	15
Using mask-fit	16
Using the menus	17
Setup menu	18
Setup menu: Clinical Settings (Mask Type)	18
Setup menu: Alarm Settings (Alarm Volume)	18
Setup menu: Options	18
Setup menu: Configuration Menu	19
Info menu	20
Event Summary	20
Used Hours	20
Device Information	20
Reminders	20
Data management	21

Cleaning and maintenance 21

- Daily 21
- Weekly 22
- Monthly 22
- Replacing the air filter 22
- Disinfection 23
- Multipatient use 23
- Servicing 24

Troubleshooting 24

- Alarm troubleshooting 24
- Other troubleshooting 27

Technical specifications 30

- Guidance and manufacturer’s declaration – electromagnetic emissions and immunity 32
- Symbols 34

General warnings and cautions 35

Limited warranty 37

Introduction

Read the entire manual before using the device. This User Guide is for a non-clinician user, and does not contain all the information provided in the Clinical Guide.

Indications for use

The Stellar 100/150 is intended to provide ventilation for non-dependent, spontaneously breathing adult and paediatric patients (13 kg and above) with respiratory insufficiency, or respiratory failure, with or without obstructive sleep apnoea. The device is for noninvasive use, or invasive use (with the use of the ResMed Leak Valve). Operation of the device includes both stationary, such as in hospital or home, or mobile, such as wheelchair usage.

Contraindications

The Stellar is contraindicated in patients who are unable to endure more than brief interruptions in ventilation. The Stellar is not a life support ventilator.

If you have any of the following conditions, tell your doctor before using this device:

- pneumothorax or pneumomediastinum
- pathologically low blood pressure, particularly if associated with intravascular volume depletion
- cerebrospinal fluid leak, recent cranial surgery or trauma
- severe bullous lung disease
- dehydration.

The use of the Stellar or pulse oximetry (including XPOD) is contraindicated in an MRI environment.

AutoEPAP¹ is contraindicated for invasive use.

Adverse effects

You should report unusual chest pain, severe headache or increased breathlessness to your prescribing physician.

The following side effects may arise during the course of noninvasive ventilation with the device:

- drying of the nose, mouth or throat
- nosebleed
- bloating
- ear or sinus discomfort
- eye irritation
- skin rashes.

¹ This feature is not available in all countries.

Stellar at a glance

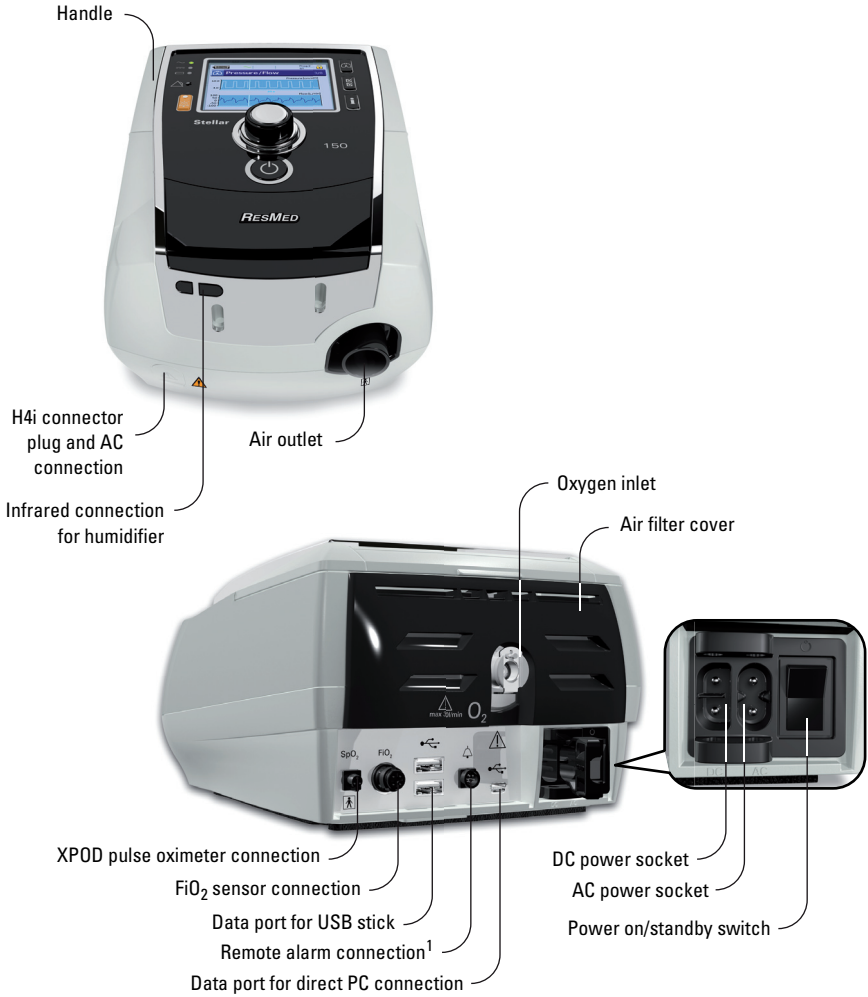

The Stellar comprises:

- Stellar device • Hypoallergenic air filter • AC power cord • Carry bag • 2 m air tubing • ResMed USB stick • Low pressure oxygen connector.

The following optional components are compatible with Stellar:

- 3 m air tubing • SlimLine™ air tubing • Clear air tubing (disposable) • H4i™ heated humidifier • Antibacterial filter • Heat moisture exchanger filter (HMEF) • ResMed XPOD oximeter • Nonin™ pulse oximetry sensors • FiO₂ monitoring kit (external cable, T-piece adapter) • FiO₂ monitoring sensor • Stellar Mobility bag • ResMed Leak Valve • Tubing wrap • Stellar DC/DC converter.



WARNING

The Stellar should only be used with air tubing and accessories recommended by ResMed. Connection of other air tubing or accessories could result in injury or damage to the device.

¹ Remote alarm connection is product model dependent.

ResMed regularly releases new products. Please check the catalogue of ventilation accessories on our website at www.resmed.com.

Patient interface

Both masks and tracheostomy tubes can be used with Stellar. To set the patient interface type go to the *Setup* menu, select *Clinical Settings*, then *Advanced Settings*.

For information on using masks, see the mask manual. For a full list of compatible masks for this device, see the Mask/Device Compatibility List on www.resmed.com on the **Products** page under **Service & Support**. If you do not have internet access, please contact your ResMed representative.

Humidification

A humidifier is recommended especially for patients experiencing dryness of the nose, throat or mouth. For information on using a humidifier as part of:

- noninvasive ventilation, see “Setting up for noninvasive use” on page 4.
- invasive ventilation, see “Setting up for invasive use” on page 5.

Internal battery



CAUTION

Over time, the capacity of the internal battery will decrease. This depends on individual use and ambient conditions. As the battery degrades, the battery charge level indicator may lose accuracy. This will mean battery-related and system alarms may not activate as intended. ResMed recommends the battery be tested after two years to assess the remaining battery life. Testing and replacement of the internal battery should only be performed by an authorised service agent.

Note: The battery duration depends on the state of charge, the environmental conditions, the condition and age of battery, the device settings and the patient circuit configuration.

In case of a mains power disruption, the device will operate using the internal battery if there is no external battery connected to the device. The internal battery will operate for approximately two hours under normal conditions (see “Technical specifications” on page 30). The power status of the battery is displayed on top of the LCD screen. Check the battery status regularly while operating the device with the internal battery and connect the device in time to mains power or alternatively to the external battery.

Additionally the Internal battery use alarm will be displayed. Press the Alarm mute button to clear the alarm.

To recharge the internal battery, connect the device to mains power. It can take up to three hours to fully recharge the internal battery, however this can vary depending on environmental conditions and if the device is in use.

Maintenance

The internal battery has to be discharged and recharged every six months.

- 1 Remove the power cord while the Stellar is turned on (stand-by or in operation) and let the device operate with the internal battery to a charge level of 50%.
- 2 Reconnect the power cord to the mains power. The internal battery will be fully recharged.

Storing

If the device is stored for a longer period the internal battery should be at the charge level of approximately 50% to increase the durability.

Note: Check the charge level every six months, if necessary recharge the internal battery to a charge level of 50%.

ResMed USB stick

A ResMed USB stick may be used with the device either to help the clinician to monitor your treatment or to provide you with updated device settings. For more information, see “Data management” on page 21.

Use on an aircraft

ResMed confirms that the Stellar can be used during all phases of air travel without further testing or approval by the airline operator. See “Technical specifications” on page 30.

Mobile use

The Stellar Mobility bag allows the Stellar to be used in mobile situations, eg, in a wheelchair. For setup and correct use, see the Stellar Mobility Bag User Guide. For extended mobile use, the ResMed Power Station II external power supply unit can be used as an additional power source. Limitations apply to the use of oxygen with the Stellar Mobility Bag. For more information, contact your local ResMed representative.

Remote Alarm

The Remote Alarm may be used to transfer audible and visual alarms by a direct cable connection. For more information on using the Remote Alarm, see the Remote Alarm user guide.

Setting up for noninvasive use



WARNING

- The air filter cover protects the device in the event of accidental liquid spillage onto the device. Ensure that the air filter and air filter cover are fitted at all times.
- Make sure that all the air inlets at the rear of the device and under the device and vents at the mask are unobstructed. If you put the device on the floor, make sure the area is free from dust and clear of bedding, clothes or other objects that could block the air inlets.
- Hoses or tubes must be non-conductive and antistatic.
- Do not leave long lengths of the air tubing or the cable for the finger pulse sensor around the top of your bed. It could twist around your head or neck while you are sleeping.



CAUTION

- Be careful not to place the device where it can be bumped or where someone is likely to trip over the power cord.
- Make sure the area around the device is dry and clean.

Notes:

- ResMed recommends using the AC power cord supplied with the unit. If a replacement power cord is required, contact your ResMed Service Centre.
- Place the device on a flat surface near the head of the bed.

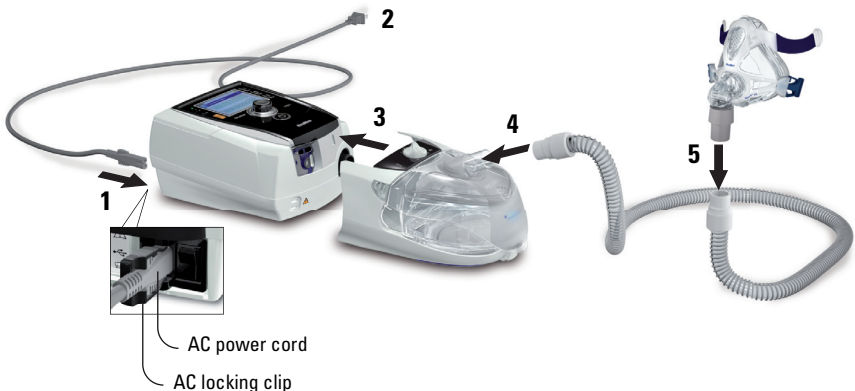

- 1 Connect the power cord.

- 2 Plug the free end of the power cord into a power outlet.
- 3 Attach the H4i heated humidifier to the front of the Stellar.
If the H4i is not in use, and if applicable, connect the antibacterial filter firmly onto the air outlet of the device (see “Attaching an antibacterial filter” on page 10).
Note: *Other external humidifiers can be used for noninvasive setup. ResMed recommends using a breathing system (including antibacterial filter, air tubings, external humidifier) with an impedance of maximum 2 cm H₂O at 30 L/min, 5 cm H₂O at 60 L/min and 16 cm H₂O at 120 L/min.*
- 4 Connect one end of the air tubing firmly onto the air outlet of the H4i.
- 5 Connect the mask system to the free end of the air tubing.
- 6 Press the power switch on the back to turn on the device.
- 7 Select the mask type (select *Setup* menu, then *Clinical Settings*, then *Advanced Settings*).
- 8 Perform Learn Circuit (see “Setup menu: Options” on page 18).

Attaching the H4i heated humidifier for noninvasive use

Use of the H4i heated humidifier may be recommended by your clinician. For information on using the H4i, see the H4i user guide.



WARNING

- Always place the H4i on a level surface below the level of the patient to prevent the mask and tubing from filling with water.
- Make sure that the water chamber is empty and thoroughly dried before transporting the humidifier.
- The H4i heated humidifier is not intended for mobile use.
- Do not overfill the water chamber, as during use this will cause water to spill into the air circuit. Check the air circuit regularly for accumulated water. If you observe water has spilled into the air circuit, clear the water and check that the water chamber is not overfilled. When using the H4i at high pressures (above 25 cm H₂O) the use of a water trap will avoid water spillage back into the air circuit.
- For optimal accuracy and synchrony, perform a Learn Circuit with a change of the circuit configuration, in particular when adding or removing high impedance components (eg, antibacterial filter, external humidifier, water trap, nasal pillow type mask or air tubing). See “Setup menu: Options” on page 18.



CAUTION

Check the air circuit for water condensation. Use a water trap or a tubing wrap if humidification is causing water condensation within the tube.

Notes:

- *A humidifier increases resistance in the air circuit and may affect triggering and cycling, and accuracy of display and delivered pressures. Therefore perform the Learn Circuit function (see “Setup menu: Options” on page 18). The device adjusts the airflow resistance.*
- *The heating feature of the H4i is disabled when the device is not mains powered.*

Setting up for invasive use

The Stellar can be used invasively only with the ResMed Leak Valve, or using an uncuffed or deflated cuff tracheostomy tube with the ResMed Leak Port (24976).

AutoEPAP is contraindicated for invasive use.



WARNING

- Make sure that all the air inlets at the rear of the device and under the device and vents at the mask or at the ResMed Leak Valve are unobstructed. If you put the device on the floor, make sure the area is free from dust and clear of bedding, clothes or other objects that could block the air inlets.
- When using a Heated Moisture Exchange Filter (HMEF), replace the HMEF regularly as specified in the instructions provided with the HMEF.

- The H4i is contraindicated for invasive use. An external humidifier approved for invasive use is recommended according to EN ISO 8185 with an absolute humidity of > 33 mg/L.
- For optimal accuracy and synchrony, perform a Learn Circuit when a new circuit is used or with a change of the circuit configuration, in particular when adding or removing high impedance components (eg, antibacterial filter, external humidifier, water trap or different type of air tubing). Do not connect patient interfaces prior to performing the Learn Circuit. Patient interfaces include any components placed after the ResMed Leak Valve (eg, HMEF, catheter mount, tracheostomy tube). See “Setup menu: Options” on page 18.



CAUTION

When using a humidifier check the breathing system regularly for accumulated water.

Notes:

- When the Mask type is set to **Trach**, the Non-Vented Mask alarm will be automatically enabled to alert you when the ResMed Leak Valve has no vent holes or when the vent holes are blocked.
- When the Mask Type is set to **Trach** AutoEPAP has to be turned off.

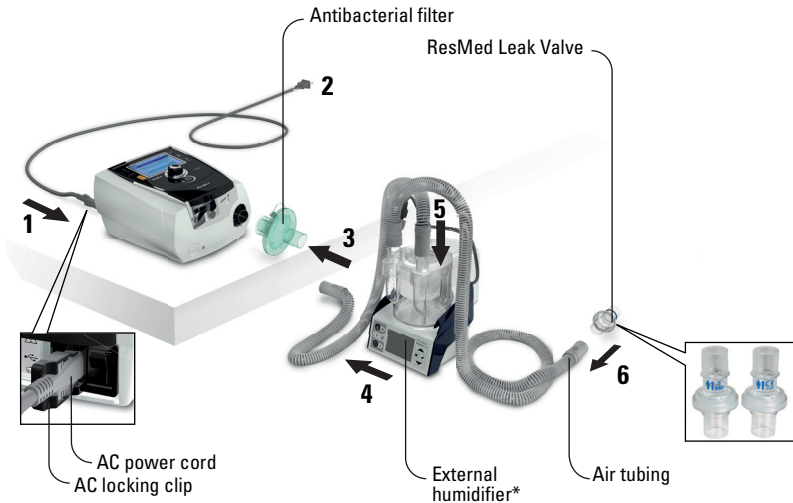

- 1 Connect the power cord.
- 2 Plug the free end of the power cord into a power outlet.
- 3 Connect the antibacterial filter firmly onto the air outlet of the device.
- 4 Connect the external humidifier to the other side of the antibacterial filter.
*If not using an external humidifier, the HMEF can be connected to the ResMed Leak Valve (at step 10).
- 5 Connect the air tubing to the external humidifier.
- 6 Connect the ResMed Leak Valve to the air tubing. Position the ResMed Leak Valve so that air from the vent holes does not blow directly onto the patient's chest.



WARNING

Always set up the ResMed Leak Valve in the breathing circuit with the arrows and the symbol  pointing in the direction of air flow from the Stellar to the patient.

- 7 Press the power switch on the back to turn on the device.
- 8 Select the mask type **Trach** (select *Setup* menu, then *Clinical Settings*, then *Advanced Settings*).

- 9** Perform a Learn Circuit (see "Setup menu: Options" on page 18) according to the following setup illustrations.

With an external humidifier

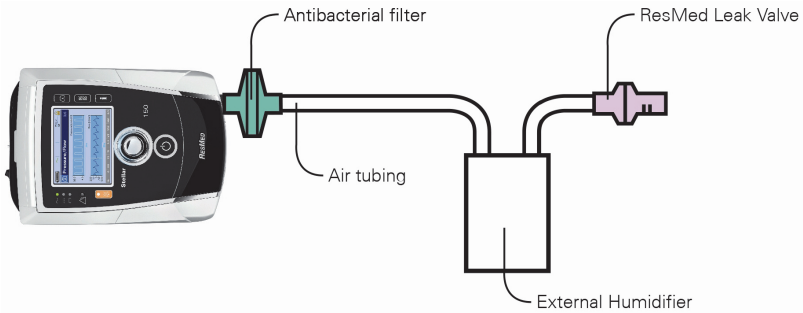

Without an external humidifier

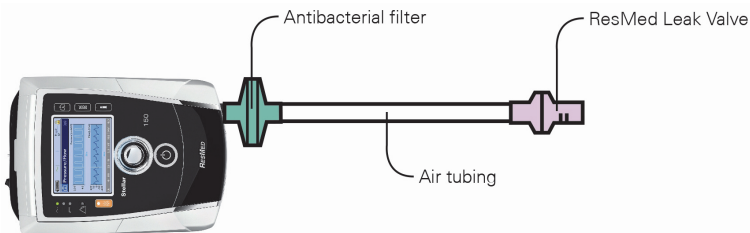

- 10** If an external humidifier is not being used, you can connect the HMEF to the patient side of the ResMed Leak Valve.
- 11** Connect the catheter mount.

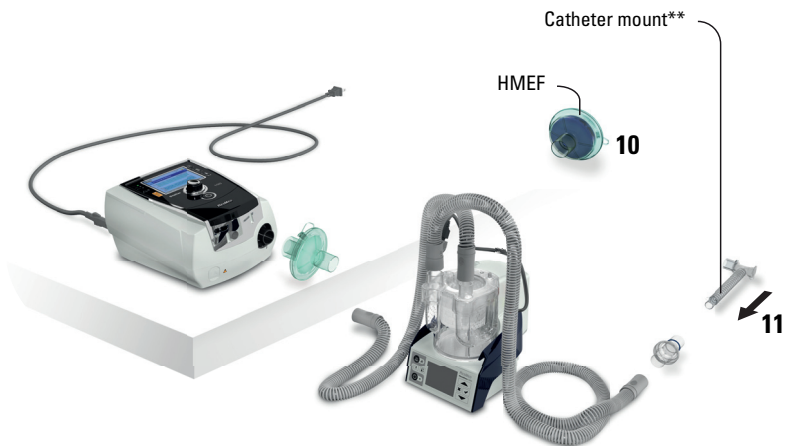

** The ResMed Leak Valve or the HMEF can be connected to standardised tracheostomy interfaces including connector pieces like catheter mounts. The catheter mount and the external humidifier are not part of the ResMed component.

Using the Stellar device for the first time

When using the Stellar device for the first time, ensure that all components are in working condition and perform a functional test (see "Performing a functional test" on page 13). Alarms should also be checked by the physician when setting up a new patient (see Clinical Guide).

Working with other optional accessories

Attaching the pulse oximeter

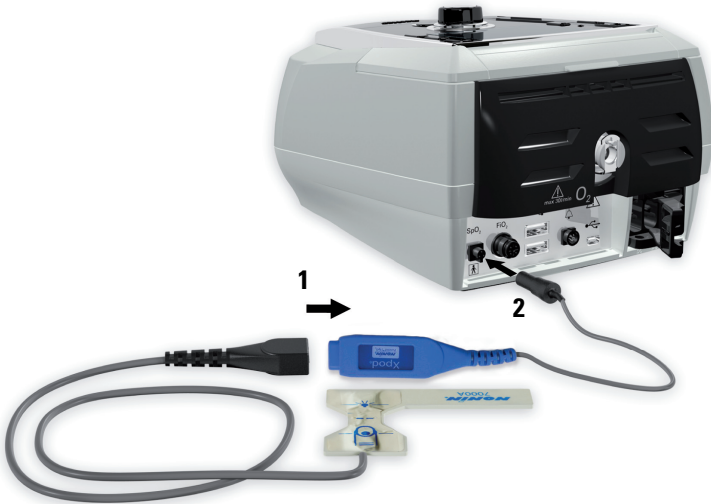

Use of a pulse oximeter may be recommended by your clinician.

Contraindication

The pulse oximeter does not meet defibrillation-proof requirement per IEC 60601-1: 1990, clause 17.h.

- 1 Connect the plug of the finger pulse sensor to the plug of the pulse oximeter.
- 2 Connect the plug of the pulse oximeter at the rear of the device.

To view the oximetry values, from the *Monitoring* menu, select *Monitoring*.

Adding supplemental oxygen

Oxygen may be prescribed by your clinician.

Note: Up to 30 L/min can be added.



WARNING

- Oxygen flow must be turned off when the device is not operating, so that unused oxygen does not accumulate within the device and create a risk of fire.
- Use only certified, clean oxygen sources.
- ResMed strongly recommends adding oxygen into Stellar's oxygen inlet at the rear of the device. Entraining oxygen elsewhere, ie into the breathing system via a side port or at the mask, has potential to impair triggering and accuracy of therapy/monitoring and alarms (eg, High Leak alarm, Non-vented mask alarm). If used in this way, therapy and alarm operation must be verified each time oxygen flow is adjusted.
- Oxygen supports combustion. Oxygen must not be used while smoking or in the presence of an open flame. Only use oxygen supply in well-ventilated rooms.
- The breathing system and the oxygen source must be kept at a minimum distance of 2 m away from any sources of ignition (eg, electrical devices).
- Oxygen must not be used while the device is being operated within the mobility bag.

To add supplemental oxygen

- 1 Unlock the low flow oxygen inlet on the back of the device by pushing up on the locking clip.
- 2 Insert one end of the oxygen supply tubing into the oxygen connector port. The tubing automatically locks into place.
- 3 Attach the other end of the oxygen supply tubing to the oxygen supply.
- 4 Start ventilation.
- 5 Turn on the oxygen source and adjust to the desired flow rate.

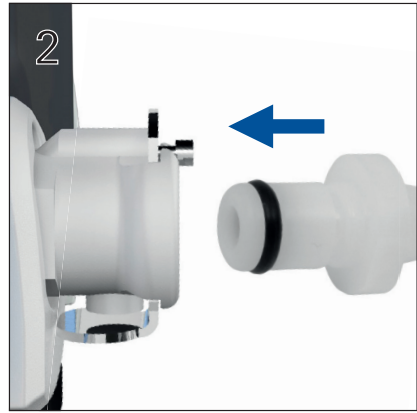
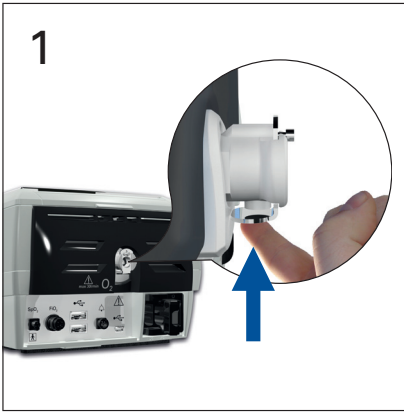

To remove supplemental oxygen

Before you remove supplemental oxygen from the device, ensure the oxygen supply has been turned off.

- 1 Unlock the low flow oxygen inlet on the back of the device by pushing up on the locking clip.
- 2 Remove the oxygen supply tubing from the oxygen connector port.

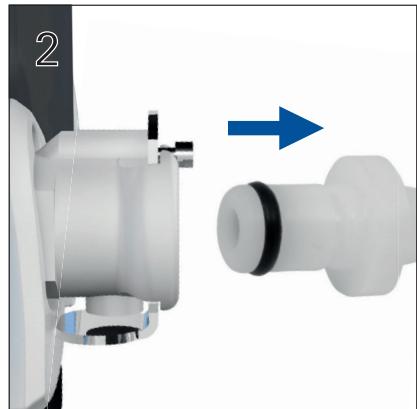
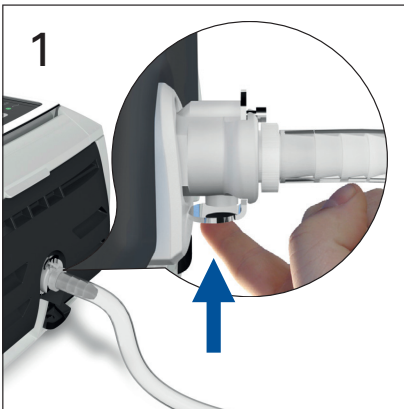

Using the FiO₂ monitoring sensor

Use of the FiO₂ monitoring sensor may be recommended by your clinician.



CAUTION

Do not use the FiO₂ monitoring sensor with the H4i humidifier.

Preparing to use a new sensor

- 1 Before use, leave the FiO₂ monitoring sensor open to the air for 15 minutes.
- 2 Attach a new FiO₂ monitoring sensor (as shown below).
- 3 Perform the sensor calibration (see "Setup menu" on page 18).

Note: The FiO₂ monitoring sensor must be replaced every 12 months.

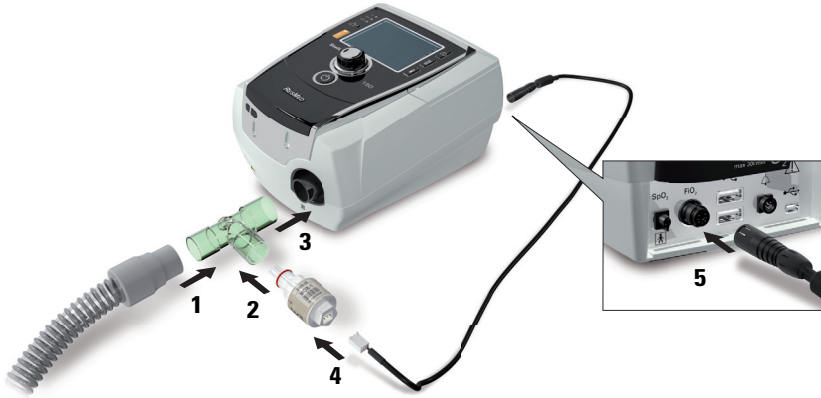

Connecting a sensor

- 1 Connect the air tubing to the T-piece adapter.
- 2 Connect the FiO₂ monitoring sensor to the T-piece adapter.
- 3 Connect the adapter to the air outlet of the device.
- 4 Connect one end of the cable to the FiO₂ monitoring sensor.
- 5 Connect the other end of the cable to the rear of the device.
- 6 Start calibration (see "Setup menu: Options" on page 18). This should be repeated periodically at the recommendation of your clinician.

Attaching an antibacterial filter

The use of an antibacterial filter may be recommended by your clinician. One antibacterial filter—product code 24966—can be purchased separately from ResMed.

Regularly check the filter for entry of moisture or other contaminants. The filter must be replaced according to the manufacturer's specifications.

Note: ResMed recommends using a filter with a low impedance (less than 2 cm H₂O at 60 L/min, eg, PALL BB 50 filter).



WARNING

Do not use the antibacterial filter (product code 24966) with the H4i.







- 1 Fit the antibacterial filter to the air outlet of the device.
- 2 Attach the air tubing to the other side of the filter.
- 3 Attach the mask system to the free end of the air tubing.
- 4 Perform the Learn Circuit function (see “Setup menu: Options” on page 18). From the *Setup* menu, select *Options*. This enables the device to compensate for the impedance introduced by the filters.

Stellar basics

About the control panel



Key	Function
Start/Stop 	<ul style="list-style-type: none"> Starts or stops treatment. Extended hold for at least three seconds starts the mask-fitting feature.
Alarm mute 	<ul style="list-style-type: none"> During therapy: Press once to mute an alarm. Press a second time to un-mute an alarm. If the problem is still present, the alarm will sound again after two minutes. See "Working with alarms" on page 15. In stand-by mode: Extended hold for at least three seconds starts the alarm LED and alarm buzzer test.
Menu keys 	Press the appropriate menu button (Monitoring, Setup, Info) to enter and scroll through the relevant menu.
Push dial 	Turning the dial allows you to scroll through the menu and change settings. Pushing the dial allows you to enter into a menu or confirm your choice.

LCD screen

The LCD screen displays the menus, monitoring screens and alarm status.

Values on this LCD screen and other screens throughout the User Guide are examples only.

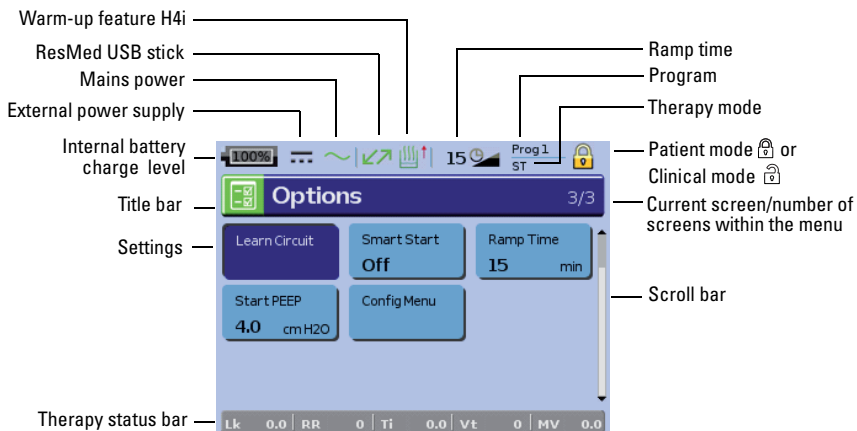

Starting therapy

Performing a functional test

Make sure your device is functioning properly each time before starting therapy. If any problems occur, see “Troubleshooting” on page 24. Please also check other provided User Instructions for troubleshooting information.

1 Turn off the device by pressing the power switch at the back of the device.

2 Check condition of device and accessories.

Inspect the device and all the provided accessories. If there are any visible defects, the system should not be used.

3 Check the circuit configuration.

Check the integrity of the circuit configuration (device and provided accessories) according to the setup descriptions in this User Guide and that all connections are secure.

4 Turn on the device and check alarms.

Press the power switch  at the back of the device once to turn on the device.

Check that the alarm sounds a test beep and the LEDs (visual indicator) for the alarm signal and the Alarm mute button flash. The device is ready for use when the *Treatment* screen is displayed. If the display shows the *Reminder* page, follow the instructions, then press  to display the *Treatment* screen.

5 Check batteries.

Disconnect the device from the mains and external battery (if in use) so that the device is powered by the internal battery. Check that the Battery use alarm is displayed and the battery LED is on.

Note: If the charge state of the internal battery is too low, or if the battery is empty, an alarm occurs. See the Alarm troubleshooting section on page 24 for further information.

Reconnect the external battery (if in use) and check that the LED for the external power supply is lit. The External DC power use alarm will be displayed and the Alarm LED will light.

Reconnect the device to the mains.

6 Check H4i heated humidifier (if in use).

Check that the warm-up feature is displayed in the *Treatment* screen. Start the warm-up feature. Check that the humidifier warm-up symbol is displayed on top of the screen.

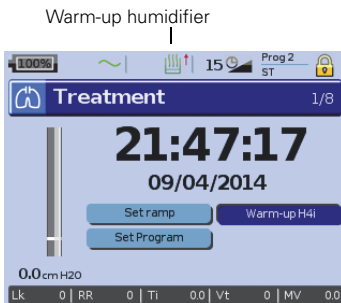

You can use the warm-up feature to pre-heat the water in the humidifier prior to starting treatment. The humidifier will be automatically detected when the device is turned on. The *Treatment* screen provides the option to start warming the humidifier. If the humidifier is heating, the related symbol is displayed at the top of the LCD screen.

For more information, see the H4i User Guide.

Note: The H4i in heating mode can only be used when the device is connected to mains supply.

7 Check the FiO₂ monitoring sensor (if in use).

Start the FiO₂ sensor calibration. Select *Setup* menu, then *Options* (see “Setup menu: Options” on page 18). Follow the instructions on the display.

8 Check pulse oximeter (if in use).

Attach the accessories according to the setup descriptions (see “Attaching the pulse oximeter” on page 8). From the *Monitoring* menu, go to the *Monitoring* screen. Check that the values for SpO₂ and Heart rate are displayed.



9 Check oxygen connection (if in use).

Attach the accessories according to the setup descriptions (see “Adding supplemental oxygen” on page 8).

Starting therapy



CAUTION

The Clinical mode  is only for clinicians. If the device is operating in clinical mode press the power switch  at the back to re-start the device in patient mode .

- 1 Fit your patient interface (mask or catheter mount) as described in the user instructions.
- 2 Lie down and arrange the air tubing so that it is free to move if you turn in your sleep or arrange the tubing so it is comfortable in your wheelchair.
- 3 To start treatment, press  **or** if the SmartStart/Stop function is enabled, simply breathe into your patient interface and treatment will begin.

Stopping therapy

You can stop therapy at any time, simply remove the patient interface and press  to stop airflow **or** if SmartStart/Stop is enabled, simply remove the patient interface, and treatment will stop automatically.

Notes:

- *SmartStop may not work if **Full face** or **Trach** is selected as mask type; the High Leak alarm or the Low Min Vent alarm is enabled; “Confirm Therapy Stop” is enabled; or the mask-fitting feature is running.*
- *When the device is stopped and operating in standby mode with an integrated humidifier connected, it will continue to blow air gently to assist cooling of the humidifier’s heater plate.*
- *Masks with high resistance (eg, paediatric masks) may cause the operation of the SmartStop feature to be restricted.*
- *When using with oxygen, turn off oxygen flow before stopping therapy.*

Turning off the power

- 1 Stop the therapy.
- 2 Press the power switch  at the back of the device once and follow the instructions on the display.

Note: To disconnect the device from the mains power pull out the power cord from the power socket.

Working with alarms



WARNING

- This device is not intended to be used for vital signs monitoring. If vital signs monitoring is required, a dedicated device should be used for this purpose.
- When adjusting alarm volume, ensure that the alarm can be heard above the ambient noise levels that the patient may experience in a variety of settings, including use in noisy environments or inside mobility bags.

This device is fitted with alarms to alert you to changes that will affect your treatment.



Alarm messages are displayed along the top of the screen. High priority alarms are displayed in **red**, medium priority alarms in **yellow** and low priority alarms in **light blue**. The Alarm LED lights **red** during high priority alarms and **yellow** during medium and low priority alarms.

The alarm volume can be set Low, Medium or High. From the Setup menu, select *Alarm Settings*. After the set value has been confirmed, the alarm will sound and the alarm LED lights.

Alarm settings, see “Setup menu: Alarm Settings (Alarm Volume)” on page 18.

You can mute an alarm by pressing once. By pressing the Alarm mute key again, the alarm sounds again. When an alarm is muted, the Alarm mute key LED will light constantly. For a high or medium priority alarm, if after two minutes the problem is still present, the alarm will sound again. Any active low priority alarm will be permanently muted and the Internal Battery Use alarm will be cleared until the alarm condition is fulfilled again.

Tailoring treatment setup options

Setting Ramp

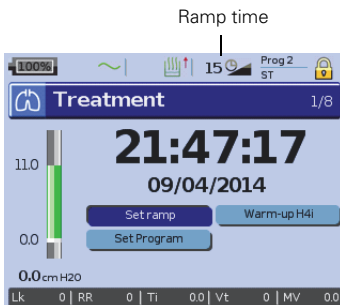

Ramp time is a feature that can be enabled by your clinician by setting a maximum ramp time. Designed to make the beginning of treatment more comfortable, ramp time is the period during which the pressure increases from a low start pressure to the treatment pressure. See “Setup menu: Options” on page 18.

Programs



Programs can be configured by your clinician to provide you with multiple treatment options. For example, a clinician can set up programs for sleeping versus waking use or for use during exercise or physiotherapy. Programs save different patient circuit configurations (Learn Circuit result) and therapy and alarm settings.

The Stellar comes with one active program. Your clinician can configure two programs. If your clinician has selected dual, you can choose the program to use on the Treatment screen after stopping treatment. If only a single program is selected, the option does not display.

Note: Each program retains its own circuit configuration. When switching between programs, ensure you use the correct circuit (breathing system) as 'learned' for that program. If more than one program has been set up, follow the directions given by your clinician for when and how each program should be used.

Ramp Down

If you experience difficulties in taking off the ventilation, you can use the Ramp Down feature. This feature reduces the treatment pressure to Start EPAP/PEEP over five minutes. After five minutes the therapy stops. You can enable the Ramp Down feature when it is selected by the physician in the Options menu.

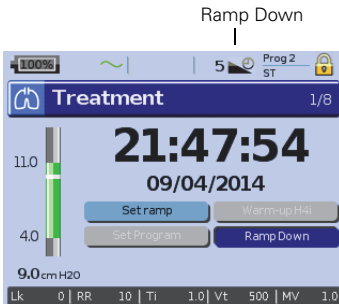



Notes:

- Therapy can be stopped at any time by pressing the therapy start/stop button, including during the Ramp Down time.
- During the Ramp Down time the low pressure alarm is not active.
- This feature is not available in all countries.

Using mask-fit

You can use mask-fit to help you fit your mask properly. This feature delivers constant treatment pressure for a three-minute period, prior to starting treatment, during which you can check and adjust your mask-fit to minimise leaks. The mask-fit pressure is the set CPAP or EPAP pressure or 10 cm H₂O, whichever is greater.

- 1 Put the mask on according to the mask user guide.
- 2 Hold down  for at least three seconds until pressure delivery starts.
- 3 If necessary adjust the mask, mask cushion and headgear until you have a good mask fit. After three minutes treatment will begin. Mask-fit can be stopped at any time by pressing .

Notes:

- Press  for at least three seconds during mask-fit to start the treatment immediately.
- The mask-fitting feature is disabled when the mask type **Trach** is selected.
- Availability of this feature is country dependent.

Using the menus

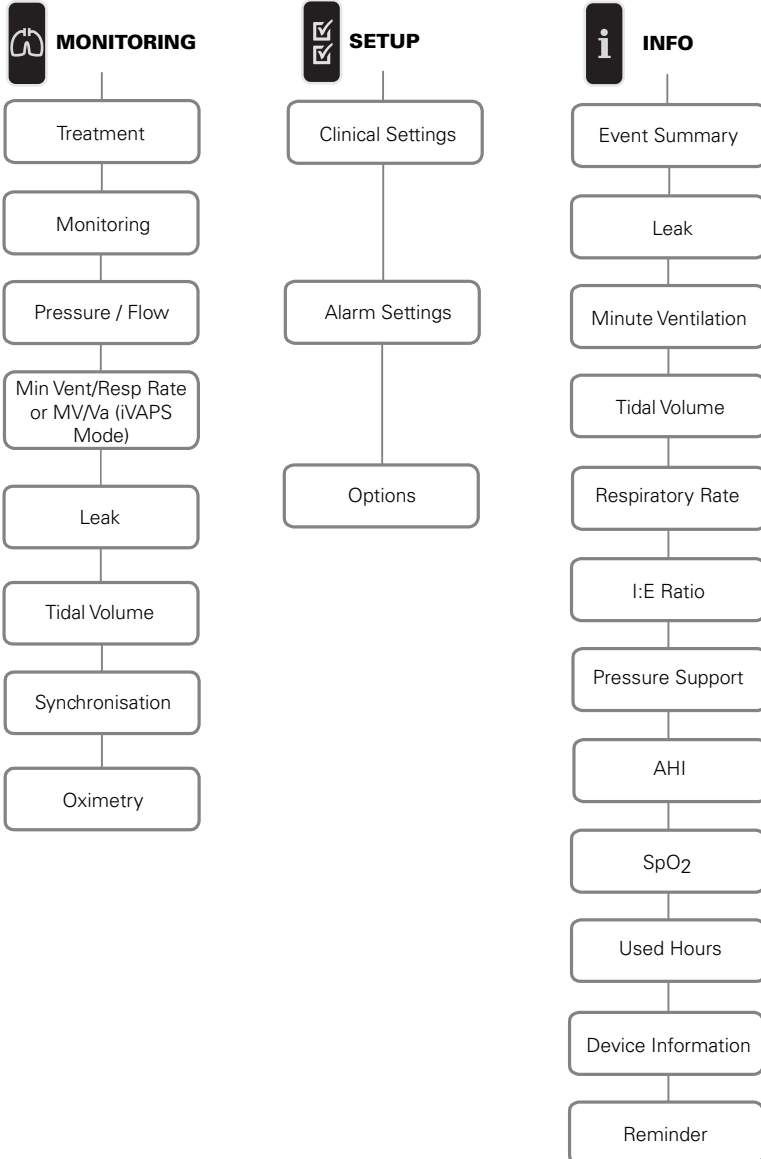

The device has three menus (*Monitoring, Setup, Info*) accessed by the equivalent buttons on the right of the LCD screen. In each menu there are screens that display settings, device or therapy information.



Note: *iVAPS mode is only available in Stellar 150.*

Setup menu

Setup menu: Clinical Settings (Mask Type)

- 1 Press  to display the *Clinical Settings* screen.
- 2 Use the push dial  to scroll through the menu and change the *Mask Type* in the *Advanced Settings* screen.





Mask type options: Nasal, Ultra, Pillow, Full Face, Trach, Pediatric.

Note: When Mask Type is set to *Trach* or *Full Face* the Non-Vented Mask alarm automatically turns on.



For a full list of compatible masks for this device, see the Mask/Device Compatibility List on www.resmed.com on the **Products** page under **Service & Support**. If you do not have internet access, please contact your ResMed representative.

Setup menu: Alarm Settings (Alarm Volume)

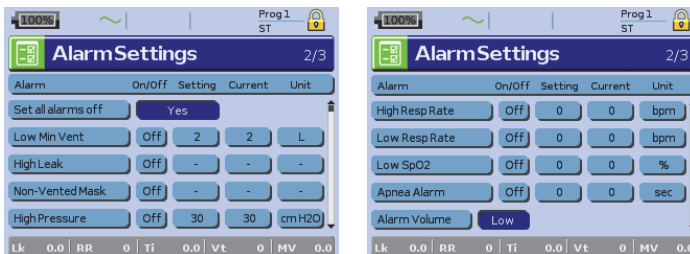



- 1 Press  to display the *Alarm Settings* screen.
- 2 Use the push dial  to scroll through the menu and change the *Alarm Volume* to low, medium or high.



Setup menu: Options

- 1 Press  to display the *Options* screen.
- 2 Use the push dial  to scroll through the menu and change parameters (see descriptions in the table below).



Parameter	Description
Learn Circuit	<p>The device is calibrated according to your air tubing system.</p> <ol style="list-style-type: none"> 1. Ensure that the therapy is turned off before performing a Learn Circuit. 2. If in use, turn off the oxygen flow. 3. Select the mask type. 4. Set up the air circuit including accessories and patient interface. <p>Note: When performing a Learn Circuit for invasive use, do not connect a catheter mount, tracheostomy tube or HMEF (see "Setting up for invasive use" on page 5).</p> <ol style="list-style-type: none"> 5. Leave the air circuit unobstructed and open to the air. 6. Press  to start the Learn Circuit. 7. Wait for the device to complete its automated tests (<30 sec). The results are displayed when complete. If the circuit configuration has been successfully learnt,  displays. If unsuccessful,  displays (see "Troubleshooting" on page 24).
FiO ₂ Sensor Calibration	<p>The device starts the calibration of the FiO₂ monitoring sensor to measure the oxygen concentration of the breathable air.</p> <ol style="list-style-type: none"> 1. Press  to start the FiO₂ sensor calibration. 2. Wait for the device to complete its calibration. The results are displayed when complete. <p>Note: Turn off the oxygen flow.</p>
Ramp Time	<p>If Max Ramp Time has been set by the clinician, you may select any value up to this time.</p> <p>Options: 0 min-Max Ramp Time (max 45 minutes, 5 minutes increments)</p>

Setup menu: Configuration Menu

Parameter	Description
Language	<p>Sets the display language.</p> <p>Options: Depending on regional configuration</p>
Brightness	<p>Sets the LCD backlight brightness.</p> <p>Options: 20-100%, 10% increments</p>
Backlight	<p>Enables the LCD and keypad backlight.</p> <p>If the AUTO setting is selected the backlight turns dark after five minutes without any actions and turns on again if any button is pressed again or an alarm occurs.</p> <p>Options: On, Auto</p>
Time format	<p>Sets the time format.</p> <p>Options: 24 hrs, 12 hrs</p>
Date format	<p>Sets the date format.</p> <p>Options: dd/mm/yyyy, mm/dd/yyyy</p>
To return to the Options screen press the Return button 	

Info menu

Event Summary

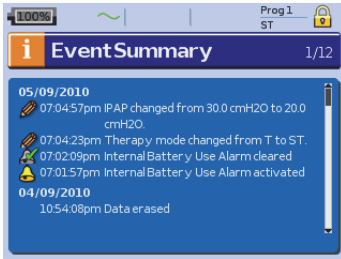

Event summary displays the summary of three types of events: changes in settings, alarms and system events (eg, connection of ResMed USB stick). There are up to 200 events of each type, displayed in chronological order, with the most recent event displayed at the top by default.

Note: When the capacity of 200 logged events is reached, the oldest log record is overwritten.

Used Hours

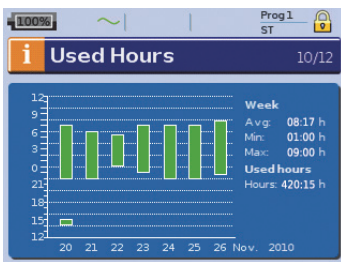

Used Hours during the last seven days of treatment are displayed in a bar graph and can be compared to the data of the last 365 days.

Device Information

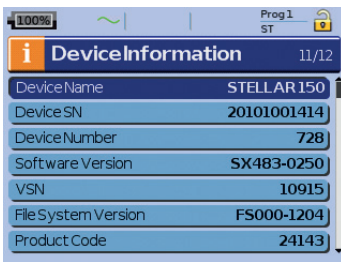

This screen shows the serial number (displayed as Device SN), device number, software version and other component versions. Data on this screen may be requested for servicing or as part of problem-solving by a technician.

Reminders



The Clinician uses the Reminders menu to alert you to specific events; for example, when to replace the mask, when to replace the filter and so on. The reminder appears in yellow as the date approaches (within 10% of the reminder period). The reminder also displays when the device is powered on. You can clear a reminder message by selecting 'Reset', which clears the current reminder date to OFF, or displays the next pre-set Reminder date.

Data management

There are two data ports at the rear of the device for connecting a USB stick (see “Stellar at a glance” on page 2). Therapy and device data can be stored on it or read from it to be used with ResMed software applications.



WARNING

Do not connect any device to the data ports other than specially designed devices recommended by ResMed. Connection of other devices could result in injury, or damage to the Stellar (see “General warnings and cautions” on page 35).



CAUTION

Do not disconnect the ResMed USB stick while data transfer is in progress. Otherwise loss of data or incorrect data may result. The download time depends on the data volume.

Notes:

- You cannot connect two ResMed USB sticks simultaneously for data communication.
- If data transfer is not possible or failed please read the troubleshooting section.
- Do not store files on the USB stick other than those created by the device or application. Unknown files may be lost during data transfer.

- 1 Plug the ResMed USB stick to one of the two USB connections on the rear side of the device.

The first dialogue for the USB data transfer is displayed automatically on the LCD. The device checks if there is enough memory capacity on the USB stick and if readable data is available.

- 2 Select one of the available options

- **Read settings**
The settings will be transferred from the connected ResMed USB stick to the Stellar.
- **Write settings**
Settings of the device will be stored on the ResMed USB stick.
- **Write settings and loggings**
Settings and loggings of the device will be stored on the ResMed USB stick.
- **Cancel**

- 3 Confirm the data transfer.

Cleaning and maintenance

The cleaning and maintenance described in this section should be carried out regularly. This also helps to prevent the risk of cross contamination. Refer to the mask, humidifier and other accessories user guide for detailed instructions for care and maintenance.



WARNING

- Beware of electric shock. Do not immerse the device, pulse oximeter or power cord in water. Turn off the device, unplug the power cord from the power socket and the device before cleaning and be sure that it is dry before reconnecting.
- The mask system and air tubing are subject to normal wear and tear. Inspect them regularly for damage.



CAUTION

The device cannot be sterilised.

Daily

Disconnect the air tubing from the device (and humidifier, if used) and hang it in a clean, dry place until next use. If the device is visibly soiled, wipe the exterior surfaces of the device and the pulse oximeter (if used) with a damp cloth and mild detergent.



CAUTION

- Do not hang the air tubing in direct sunlight as the tubing may harden over time and eventually crack.
- Do not use bleach, chlorine, alcohol or aromatic-based solutions (including all scented oils), moisturising or antibacterial soaps to clean the air tubing or the device on a daily basis (other than the approved cleaning agents Mikrozyd[®] AF or CaviCide[®]). These solutions may cause hardening and reduce the life of the product. The use of cleaners and disinfecting solutions containing alcohol (other than the approved cleaning agents) is acceptable for periodic cleaning of the device, such as for cleaning between patients or especially for service periods, but not recommended for daily use.

Weekly

- 1 Remove the air tubing from the device *and* the patient interface.
- 2 Wash the air tubing in warm water using mild detergent.
- 3 Rinse thoroughly, hang and allow to dry.
- 4 Reconnect the air tubing to the air outlet and patient interface.
- 5 If the device is visibly soiled, wipe the exterior surfaces of the device and the pulse oximeter (if used) with a damp cloth and mild detergent.

Monthly

- 1 Wipe the exterior of the device and the pulse oximeter (if used) with a damp cloth and mild detergent.
- 2 Visually inspect the air filter to check if it is blocked by dirt or contains holes.

Replacing the air filter

Replace the air filter every six months (or more often if necessary).



WARNING

Do not wash the air filter. The air filter is not washable or reusable.

- 1 Remove the air filter cover from the back of the device.
- 2 Remove and discard the old air filter.
- 3 Insert a new air filter.
- 4 Refit the air filter cover.

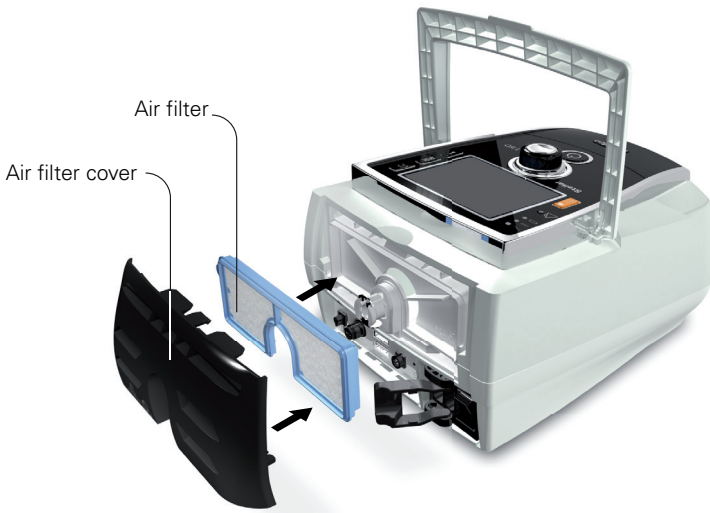

Disinfection

Disinfection of your device helps to prevent the risk of cross contamination.

Disinfect the exterior of the device, and especially the air outlet, with a damp cloth and a disinfection solution (eg, Microzid).

Multipatient use



WARNING

- An antibacterial filter is mandatory if the device is used on multiple patients.
- In a multipatient use environment, you must perform the following before the device is provided to a new patient:

Mask

Reprocess; Cleaning, disinfection and sterilisation instructions are available from the ResMed website, www.resmed.com/masks/sterilization. If you do not have Internet access, please contact your ResMed representative.

Air tubing

Replace the air tubing. Alternatively, consult the air tubing instructions for cleaning and disinfection information.

Device

Disinfect the Stellar as follows:

Use an anti-bacterial cleaning/disinfectant solution such as Mikrozid® AF or CaviCide® with a clean non-dyed disposable cloth to clean and disinfect the exterior surfaces of the device. Wipe all accessible surfaces of the device, including the air outlet (avoid liquid entering any openings in the device). Follow the manufacturer's recommended cleaning instructions.

Humidifier

As instructions for humidifiers vary, see the user guide for the humidifier in use. For multipatient use environment, use the H4i water chamber (disposable) in place of the H4i reusable water chamber.

Servicing



CAUTION

Inspection and repair should only be performed by an authorised agent. Under no circumstances should you attempt to open, service or repair the device yourself.

This product should be inspected by an authorised ResMed service centre five years from the date of manufacture, except for the internal battery which ResMed recommends be tested after two years to assess the battery life. Prior to this, the device is intended to provide safe and reliable operation provided that it is operated and maintained in accordance with the instructions provided by ResMed. Applicable ResMed warranty details are provided with the device at the time of original supply. Of course, as with all electrical devices, if any irregularity becomes apparent, you should exercise caution and have the device inspected by an authorised ResMed service centre.

Troubleshooting

If there is a problem, try the following suggestions. If a problem cannot be solved, contact ResMed.

Alarm troubleshooting

The most common reason for an alarm to sound is because the system has not been properly assembled. Check that the air tubing has been properly attached to the device and patient interface (and humidifier if used).

Notes:

- *The alarm log and alarm settings are maintained when the device is powered down and in the event of a power loss.*
- *If multiple alarms are active simultaneously, the alarm with the highest priority will be displayed first.*
- *If an alarm activates repeatedly, discontinue use and return the device for servicing.*

Problem / possible cause	Action
LCD: Internal Battery Empty!	
The remaining battery charge is below 15%. The device can be powered by the internal battery for maximum 2 minutes.	Connect the device to mains power. Note: <i>In case of a total power failure, the therapy settings will be stored and therapy will resume when the device is powered again.</i>
LCD: System Failure!	
Component failure. The device stops delivering air pressure (system failure 6, 7, 9, 22, 38). Therapy cannot be started (system failure 21).	<ol style="list-style-type: none">1. Power-off the device.2. Power-on the device again.
The device internal temperature is too low for the device to start/deliver therapy (system failure 21).	<ol style="list-style-type: none">1. Ensure that ambient temperature is above 5°C. If the device has been stored below 5°C, allow sufficient time for it to acclimatise before use.2. Power-off the device.3. Power-on the device again. If the problem persists, return the device for servicing.

Problem / possible cause	Action
The self test of the device fails and therapy cannot be started (system failure 21).	<ol style="list-style-type: none"> 1. Power-off the device. 2. Power-on the device again. If the problem persists, return the device for servicing.
Component failure (system failure 8, 25).	<ol style="list-style-type: none"> 1. Power-off the device. 2. Power-on the device again.
LCD: Over Pressure!	
The device generates a pressure that is greater than 59 cm H ₂ O. Treatment will be stopped.	<ol style="list-style-type: none"> 1. Power-off the device. 2. Check that the air tubing is connected properly. 3. Power-on the device again. 4. Start Learn Circuit function. <p><i>Note: If the alarm activates repeatedly internal components may be defective. Discontinue use and return the device for servicing.</i></p>
LCD: Blocked Tube!	
Air path is blocked.	<ol style="list-style-type: none"> 1. Check the air path for any blockages. 2. Remove the blockages. 3. If the alarm is not cleared, stop treatment. 4. Re-start treatment.
LCD: High Temperature [10, 11, 12, 23]!	
The temperature inside the device is too high. Treatment may lead to stop.	Ensure the ambient temperature is within the specified operating range. If the problem persists within the specified operating conditions please return the device for servicing. Contact your clinician.
LCD: High Pressure!	
Therapy pressure exceeds pre-set alarm level.	<ol style="list-style-type: none"> 1. Stop treatment. 2. Re-start treatment. If the problem persists contact your clinician.
LCD: Low Pressure!	
The air tubing is not connected properly.	<ol style="list-style-type: none"> 1. Check the air circuit integrity and reconnect. 2. If the alarm doesn't get cleared, stop treatment. 3. Re-start treatment.
LCD: Circuit disconnected!	
The air circuit is not connected properly.	<ol style="list-style-type: none"> 1. Check the air circuit integrity and reconnect. 2. If the alarm is not cleared, stop treatment. 3. Re-start treatment.
LCD: Low Minute Ventilation!	
Minute ventilation level has dropped below the alarm setting level.	Contact your clinician.

Problem / possible cause	Action
LCD: Low Respiratory Rate!, High Respiratory Rate!	
The respiratory rate level has dropped below or has exceeded the alarm setting level.	Contact your clinician.
LCD: High Leak!	
High mask leak for more than 20 seconds.	<ul style="list-style-type: none"> Adjust the mask to minimise leak (see "Using mask-fit" on page 16). Check the air circuit integrity and reconnect. If the problem persists contact your clinician.
LCD: Non-Vented Mask!	
<ul style="list-style-type: none"> Connection of a non-vented mask. Mask vents may be blocked. ResMed Leak Valve is missing or vent is blocked. 	<ul style="list-style-type: none"> Ensure the mask has vents. Ensure the mask vents are not blocked. Ensure the ResMed Leak Valve is installed and that the vent is not blocked. Ensure oxygen (if in use) has only been connected at the rear of the device. If the problem persists contact your clinician.
LCD: Apnoea!	
The device detects an apnoea that has exceeded the pre-set alarm level.	<ul style="list-style-type: none"> Breathe normally to disable the alarm. If the problem persists contact your clinician.
LCD: Internal Battery Low!	
The internal battery capacity is below 30%.	Connect the device to mains power.
LCD: Low SpO₂!	
SpO ₂ has dropped below pre-set alarm level.	<ul style="list-style-type: none"> Check the attachment of the sensor. If the problem persists contact your clinician.
LCD: SpO₂ finger sensor failure!	
The finger sensor is not connected properly or delivers faulty values.	Check if the finger sensor is attached properly to the finger and connection to the pulse oximeter.
LCD: Xpod oximeter disconnected!	
The pulse oximeter is disconnected.	Check if the pulse oximeter is connected properly to the device.
LCD: Low FiO₂ Level!	
FiO ₂ has dropped below the pre-set alarm level.	<ul style="list-style-type: none"> Perform FiO₂ sensor calibration. If the problem persists contact your clinician.
LCD: High FiO₂ Level!	
FiO ₂ has exceeded the pre-set alarm level.	<ul style="list-style-type: none"> Perform FiO₂ sensor calibration. If the problem persists contact your clinician.

Problem / possible cause	Action
LCD: FiO₂ sensor disconnected!	
The FiO ₂ monitoring sensor is not connected.	Connect the FiO ₂ monitoring sensor or replace it with a new one.
LCD: Keypad Failure!	
One of the keys was held down for more than 10 seconds or got stuck.	Remove any blockages from the keypad.
LCD: Attention High Temp [42, 43, 44, 45]!	
The temperature inside the device is high.	Ensure the ambient temperature conditions are within the specified operating range.
LCD: Internal Battery Use!	
The device is using the internal battery.	Check if the power cord is properly connected to the device if you want to run from mains power. Press the Alarm mute button  to cancel the alarm.
LCD: External DC Power Use!	
The device is powered by an external battery.	Check if the AC power cord is properly connected to the device if you want to run from mains power. Note: <i>The alarm will be cleared automatically after one minute.</i>

Other troubleshooting

Problem / possible cause	Solution
No display	
Power failure. The device stops delivering air pressure.	<ul style="list-style-type: none"> Remove the mask or the catheter mount from the tracheostomy tube until power is restored. Check the power cable connection between the mains power or external battery and the device. As the internal battery ages, the available capacity decreases. When the remaining battery capacity is low, it can affect the battery charge level indication and lead to power failure without activating Low or Empty battery alarms. ResMed recommends the battery be tested after two years to assess the remaining battery life (see "Internal battery" on page 3).
Power not connected or device is not switched on.	Ensure the power cord is connected and press the switch at the back of the device once.
Treatment pressure seems low	
Ramp time is in use.	Wait for air pressure to build up.
Air filter is dirty.	Replace air filter.

Problem / possible cause	Solution
Air tubing is kinked or punctured.	Straighten or replace tubing.
Air tubing is not connected properly.	Connect the air tubing firmly at both ends.
Mask and headgear not positioned correctly.	Adjust position of mask and headgear.
Plug(s) missing from access port(s) on mask.	Replace plug(s).
Pressure required for treatment may have changed.	See your clinician to adjust the pressure.
There is a large impedance (eg, antibacterial filter) in the air circuit.	Perform the Learn Circuit function.
Humidifier control dial set too high, resulting in accumulation of water in the air tubing.	Turn humidifier control down and empty the water from the air tubing.
Treatment pressure seems high	
Pressure required for treatment may have changed.	Consult your clinician.
There is a change in the impedance in the circuit configuration.	Perform the Learn Circuit function.
The device does not start when you breathe into the mask	
SmartStart/Stop not on.	Consult your clinician.
Breath is not deep enough to trigger SmartStart.	Take a deep breath in and out through the mask.
There is excessive leak.	Adjust position of mask and headgear.
Plug(s) missing from port(s) on mask.	Replace plug(s).
Air tubing is not connected properly.	Connect firmly at both ends.
Air tubing is kinked or punctured.	Straighten or replace tubing.
There is a large impedance (eg, antibacterial filter) in the air circuit.	Perform the Learn Circuit function.
The device does not stop when you remove your mask	
SmartStart/Stop is disabled.	Consult your clinician.
Use of a full face mask or tracheostomy tube.	SmartStart is disabled if Full face mask or Trach is selected as interface.
Incompatible accessories (eg, humidifier or mask system) with high resistance being used.	Use only equipment as recommended and supplied by ResMed.
High Leak Alarm or Low Min Vent alarms are set to ON.	Consult your clinician.
"Confirm Stop" is enabled.	Consult your clinician.
High Leak Alarm is enabled, but alarm does not activate when the mask is removed during treatment	
Incompatible air delivery system being used.	Use only equipment as recommended and supplied by ResMed.

Problem / possible cause	Solution
Pressure settings are too low for the air delivery components being used.	Perform the Learn Circuit function to adjust the therapy pressure according to your air tubing system.
Learn Circuit failed	
<ul style="list-style-type: none"> The circuit configuration is inappropriate as the impedance detected is too high. Too many components have been included or the impedance of accessories in use is above ResMed's recommendation, eg, type of filter, external humidifier, air tubing. 	Review the components included in the circuit configuration and adjust as appropriate, then rerun Learn Circuit (see "Setup menu" on page 18).
The delivered airflow is not humid/heated although the H4i humidifier is in use	
The humidifier is not properly attached.	Correctly attach the humidifier.
The humidifier does not heat.	The device is currently powered by battery use or not connected to the mains.
The humidifier does not work.	Return the device and the humidifier for servicing.
The water chamber is empty.	Fill the water chamber of the humidifier.
USB stick is not readable or writeable	
The USB stick contains unreadable data, does not have enough space available, is not compatible with the device.	Consult your clinician.
USB stick is defective.	Replace the USB stick after consulting your clinician.
FiO₂ sensor calibration failure	
FiO ₂ sensor is not attached properly.	For the correct attachment of the FiO ₂ sensor, see "Using the FiO ₂ monitoring sensor" on page 10.
FiO ₂ sensor is used or defective.	If the lifetime of the FiO ₂ sensor has exceeded one year please replace the FiO ₂ sensor and start calibration again.
LCD:  is displayed in the header.	
Battery is not charging.	<ul style="list-style-type: none"> Ensure the ambient temperature conditions are within the specified operating range. If the problem persists within the specified operating conditions please return the device for servicing. Power off the device. Power on the device again.

Technical specifications

Operating pressure range	<ul style="list-style-type: none"> • IPAP: 2 cm H₂O to 40 cm H₂O (in S, ST, T, PAC mode) • PS: 0 cm H₂O to 38 cm H₂O (in S, ST, T, PAC mode) • EPAP: 2 cm H₂O to 25 cm H₂O (in S, ST, T, iVAPS, PAC mode) • CPAP: 4 cm H₂O to 20 cm H₂O (in CPAP mode only) • Min PS: 0 cm H₂O to 20 cm H₂O (in iVAPS mode) • Max PS: 0 cm H₂O to 30 cm H₂O; 8 cm H₂O to 30 cm H₂O when AutoEPAP is on (in iVAPS mode) • Min EPAP/Max EPAP: 2 cm H₂O to 25 cm H₂O (in iVAPS mode when AutoEPAP is set to on) <p>Note: <i>iVAPS mode is only available in Stellar 150.</i></p>
Maximum single fault pressure	60 cm H ₂ O (in all modes)
Maximum breathing resistance under single fault	2 cm H ₂ O at 30 L/min; 7.2 cm H ₂ O at 60 L/min
Maximum flow	> 200 L/min at 20 cm H ₂ O
Flow accuracy	± 5 L/min or 20% measured value, whichever is greater Test condition: T mode, IPAP: 40 cm H ₂ O, EPAP: 2 cm H ₂ O, Rise Time: MIN, Fall Time: MIN, Ti: 4.0 sec, Respiratory Rate: 10 bpm, with ResMed calibration cap.
Therapy pressure tolerance	IPAP: ± 0.5 cm H ₂ O ± 10% of set pressure (end of inspiration) EPAP/PEEP: ± 0.5 cm H ₂ O ± 4% of set pressure CPAP: ± 0.5 cm H ₂ O ± 10% of set pressure Test condition: T mode, IPAP: 40 cm H ₂ O, EPAP: 2 cm H ₂ O, Rise Time: MIN, Fall Time: MIN, Ti: 4.0 sec, Respiratory Rate: 10 bpm, with ResMed calibration cap.
Sound pressure level	31 dBA with uncertainty of 3 dBA as measured according to ISO 17510 – 1:2007.
Sound power level	39 dBA with uncertainty of 3 dBA as measured according to ISO 17510 – 1:2007.
Alarm Volume Range	High, medium and low priority alarm (measured according to IEC 60601-1-8: 2012): minimum 41 dB maximum 67 dB
Dimensions (L x W x H)	230 mm x 170 mm x 120 mm
Weight	2.1 kg
LCD screen	Dimension (L x W x H): 76.9 mm x 63.9 mm x 3.15 mm Resolution: 320 x 240 pixels
Air outlet	22 mm taper, compatible with ISO 5356-1:2004 Anaesthetic & Respiratory Equipment - Conical Connectors
Pressure measurement	Internally mounted pressure transducer
Flow measurement	Internally mounted flow transducer
Power supply	AC 100–240V, 50–60Hz, 2.2 A, max. 65 W
External DC Power Supply (isolated)	24 V, 3 A

Internal Battery	Lithium-Ion battery, 14.4 V, 1.6 Ah, 23 Wh Operating hours: 2 h with a new battery under normal conditions (see below). Patient type: home chronic; pressure: IPAP/EPAP 15/5 cm H ₂ O; mask type: Ultra Mirage; air tubing: 2 m; leak: 0; respiratory rate: 20 bpm; battery capacity: 100% Patient type: hospital acute; pressure: IPAP/EPAP 20/5 cm H ₂ O; mask type: Ultra Mirage; air tubing: 2 m; leak: 0; respiratory rate: 45 bpm; battery capacity: 100%
Housing construction	Flame retardant engineering thermoplastic
Environmental conditions	<ul style="list-style-type: none"> • Operating temperature: 0°C to 35°C • Operating humidity: 10%–95% non-condensing • Storage and transport temperature: -20°C to 60°C (+50°C*) • Storage and transport humidity: 10%–95% non-condensing • Air pressure: 680hPa to 1,100hPa; Altitude: 3,000 m *NONIN XPOD
Electromagnetic compatibility	Product complies with all applicable electromagnetic compatibility requirements (EMC) according to IEC60601-1-2, for residential, commercial, and light industry environments. For further details see “Guidance and manufacturer’s declaration – electromagnetic emissions and immunity” on page 32.
Air filter	Electro static fibre mesh with TPE frame structure. Bacterial filtration efficiency of 99.540% on area weight 100g/m ² .
Air tubing	Flexible plastic, 2 m or 3 m length (22 mm diameter)
SlimLine air tubing	Flexible plastic, 1.83 m length (15 mm diameter)
IEC 60601-1 classifications	<ul style="list-style-type: none"> • Class II (Clause 3.14—double insulation). This adherence means the need for a protective earthing (ie, an earthed plug) is not necessary. • Type BF • Continuous operation
Air travel requirements	Medical-Portable Electronic Devices (M-PED) that meet the Federal Aviation Administration (FAA) requirements of RTCA/DO-160 can be used during all phases of air travel without further testing or approval by the airline operator. ResMed confirms that the Stellar meets RTCA/DO-160 requirements.

This device is not suitable for use in the presence of a flammable anesthetic mixture.

Notes:

- *The manufacturer reserves the right to change these specifications without notice.*
- *Pressure may be displayed in cm H₂O or hPa.*

Guidance and manufacturer's declaration – electromagnetic emissions and immunity

Medical Electrical Equipment needs special precautions regarding EMC and needs to be installed and put into service according to EMC information provided in this document.

Guidance and manufacturer's declaration – electromagnetic emissions

The device is intended for use in the electromagnetic environment specified below. The customer or the user of the device should assure that it is used in such an environment.

Emissions test	Compliance	Electromagnetic environment - guidance
RF emissions CISPR11	Group 1	The device uses RF energy only for its internal function. Therefore, its RF emissions are very low and are not likely to cause any interference in nearby electronic equipment.
RF emissions CISPR 11	Class B	The device is suitable for use in all establishments, including domestic establishments and those directly connected to the public low-voltage network that supplies buildings used for domestic purposes.
Harmonic Emissions IEC 61000-3-2	Class A	
Voltage Fluctuations/Flicker Emissions IEC 61000-3-3	Complies	

Warnings: The device should not be used adjacent to or stacked with other equipment.

If adjacent or stacked use is necessary, the device should be observed to verify normal operation in the configuration in which it will be used.

The use of accessories (eg, humidifiers) other than those specified in this manual is not recommended. They may result in increased emissions or decreased immunity of the device.

Guidance and manufacturer's declaration – electromagnetic immunity

The device is intended for use in the electromagnetic environment specified below. The customer or the user of the device should assure that it is used in such an environment.

Immunity test	IEC60601-1-2 test level	Compliance level	Electromagnetic environment –guidance
Electrostatic discharge (ESD) IEC 61000-4-2	±6 kV contact ±8 kV air	±6 kV contact ±8 kV air	Floors should be wood, concrete or ceramic tile. If floors are covered with synthetic material, the relative humidity should be at least 30%.
Electrical fast transient/burst IEC 61000-4-4	±2 kV for power supply lines ±1 kV for input/output lines	±2 kV ±1 kV	Mains power quality should be that of a typical commercial or hospital environment.
Surge IEC 61000-4-5	±1 kV differential mode ±2 kV common mode	±1 kV differential mode ±2 kV common mode	Mains power quality should be that of a typical commercial or hospital environment.
Voltage dips, short interruptions and voltage variations on power supply input lines IEC 61000-4-11	<5% Ut (>95% dip in Ut) for 0.5 cycle 40% Ut (60% dip in Ut) for 5 cycles 70% Ut (30% dip in Ut) for 25 cycles <5% Ut (>95% dip in Ut) for 5 sec	< 12 V (>95% dip in 240V) for 0,5 cycle 96 V (60% dip in 240 V) for 5 cycles 168 V (30% dip in 240 V) for 25 cycles <12 V (>95% dip in 240 V) for 5 sec	Mains power quality should be that of a typical commercial or hospital environment. If the user of the device requires continued operation during power mains interruptions, it is recommended that the device be powered from an uninterruptible power source.
Power frequency (50/60 Hz) magnetic field IEC 61000-4-8	3 A/m	3 A/m	Power frequency magnetic fields should be at levels characteristic of a typical location in a typical commercial or hospital environment.

Conducted RF IEC 61000-4-6	3 Vrms 150 kHz to 80 MHz	3 Vrms	Portable and mobile RF communications equipment should be used no closer to any part of the device, including cables, than the recommended separation distance calculated from the equation applicable to the frequency of the transmitter. Recommended separation distance: $d = 1.17 \sqrt{P}$ $d = 1.17 \sqrt{P}$ 80 MHz to 800 MHz $d = 2.33 \sqrt{P}$ 800 MHz to 2.5 GHz where P is the maximum output power rating of the transmitter in watts (W) according to the transmitter manufacturer and d is the recommended separation distance in metres (m). Field strengths from fixed RF transmitters, as determined by an electromagnetic site survey, ^a should be less than the compliance level in each frequency range. ^b Interference may occur in the vicinity of equipment marked with the following symbol: 
Radiated RF IEC 61000-4-3	3 V/m 80 MHz to 2.5 GHz	3 V/m	

NOTE 1: Ut is the AC mains voltage prior to application of the test level.

NOTE 2: At 80 MHz and 800 MHz, the higher frequency range applies.

NOTE 3: These guidelines may not apply in all situations. Electromagnetic propagation is affected by absorption and reflection from structures, objects and people.

^a Field strengths from fixed transmitters, such as base stations for radio (cellular/cordless) telephones and land mobile radios, amateur radio, AM and FM radio broadcast and TV broadcast cannot be predicted theoretically with accuracy. To assess the electromagnetic environment due to fixed RF transmitters, an electromagnetic site survey should be considered. If the measured field strength in the location in which the device is used exceeds the applicable RF compliance level above, the device should be observed to verify normal operation. If abnormal performance is observed, additional measures may be necessary, such as reorienting or relocating the device.

^b Over the frequency range 150 kHz to 80 MHz, field strengths should be less than 3 V/m.

Recommended separation distances between portable and mobile RF communications equipment and the device

The device is intended for use in an environment in which radiated RF disturbances are controlled. The customer or the user of the device can help prevent electromagnetic interference by maintaining a minimum distance between portable and mobile RF communications equipment (transmitters) and the device as recommended below, according to the maximum output power of the communications equipment.























Rated maximum output power of transmitter (W)	Separation distance according to frequency of transmitter (m)		
	150 kHz to 80 MHz $d = 1.17 \sqrt{P}$	80 MHz to 800 MHz $d = 1.17 \sqrt{P}$	800 MHz to 2.5 GHz $d = 2.33 \sqrt{P}$
0.01	0.12	0.12	0.23
0.1	0.37	0.37	0.74
1	1.17	1.17	2.33
10	3.70	3.70	7.37
100	11.70	11.70	23.30

For transmitters rated at a maximum output power not listed above, the recommended separation distance d in metres (m) can be determined using the equation applicable to the frequency of the transmitter, where P is the maximum output power rating of the transmitter in watts (W) according to the transmitter manufacturer.

NOTE 1: At 80 MHz and 800 MHz, the separation distance for the higher frequency range applies.

NOTE 2: These guidelines may not apply in all situations. Electromagnetic propagation is affected by absorption and reflection from structures, objects and people.

Symbols

 Follow instructions for use;  Class II equipment;  Type BF applied part;
 Bell (Remote Alarm); **IP31** Device is protected against solid foreign objects of 2.5 mm diameter and greater and vertically falling water drops;  Caution;  General warning sign (see H4i connector plug and AC connection on the device);  Standby or preparatory state for a part of equipment; O_2 Connection for oxygen supply; **max 30 l/min** (max 30 L/min);  Data port;  CE labeling in accordance with EC directive 93/42/EEC, class II b;  Temperature limitation for storage and transport;  Handle with care;  Maximum humidity;  Keep dry;  Manufacturer;  Upside;  Catalogue number;  **SN** Serial number;  **LOT** Batch code;  Do not re-use;  Use by date;  Keep away from sunlight;  Do not use if package is damaged;  Latex-free

Environmental information This device must be disposed of in accordance with the laws and regulations of the country in which disposal occurs.

The crossed-out wheeled bin symbol  indicates that the product bearing this symbol may not be disposed of together with general household waste, but instead requires separate disposal. This requirement for separate disposal is based on the European Directive 2012/19/EU for electrical and electronic equipment, and the European Directive 2006/66/EC for batteries. You can hand in the product at a municipal collection point, for example. This reduces the impact on natural resources and prevents contamination of the environment through the release of hazardous substances.

Batteries containing more than 0.0005 percent of mercury by mass, more than 0.002 percent of cadmium by mass or more than 0.004 percent of lead by mass are marked below the crossed-bin symbol with the chemical symbols (Hg, Cd, Pb) of the metals for which the limit is exceeded.

For further information regarding product disposal, please contact your local ResMed office or your specialist distributor, or visit our website at www.resmed.com.

Dispose of used air filters and air tubings according to the directives in your country.

General warnings and cautions



WARNINGS

A **warning** alerts you to possible injury.

- Read the entire manual before using the device.
- This device should only be used with air tubing and accessories recommended by ResMed or the prescribing clinician. Use of incorrect air tubing and accessories may affect the functioning of this device.
- The device and the accessories are to be used for the specified intended use only.
- The device must only be used with masks (and connectors¹) recommended by ResMed, or by a clinician or respiratory therapist. A mask should not be used unless the device is turned on and operating properly. The vent hole or holes associated with the mask should never be blocked.

Explanation: The Stellar is intended to be used with special masks (or connectors¹) which have vent holes to allow continuous flow of air out of the mask. When the device is turned on and functioning properly, new air from the device flushes the exhaled air out through the mask vent holes. However, when the device is not operating, insufficient fresh air will be provided through the mask, and the exhaled air may be rebreathed.

Rebreathing of exhaled air for longer than several minutes can, in some circumstances, lead to suffocation. This applies to most Positive Airway Pressure devices.

- In the event of power failure² or machine malfunction, remove the mask or the catheter mount from the tracheostomy tube.
- Explosion hazard – do not use in the vicinity of flammable anesthetics.
- Do not use the device if there are obvious external defects, unexplained changes in performance.
- Only use original and approved ResMed accessories and parts.
- Use only accessories from the original package. If the packaging is damaged, the respective product must not be used, and should be disposed along with the packaging.
- Before using the device and the accessories for the first time, ensure that all components are in a proper condition and that their operational safety is guaranteed. If there are any defects, the system should not be used.
- Additional equipment connected to medical electrical equipment must comply with the respective IEC or ISO standards (eg, IEC 60950 for data processing equipment). Furthermore all configurations shall comply with the requirements for medical electrical systems (see IEC 60601-1-1 or clause 16 of the 3Ed. of IEC 60601-1, respectively). Anybody connecting additional equipment to medical electrical equipment configures a medical system and is therefore responsible that the system complies with the requirements for medical electrical systems. Attention is drawn to the fact that local laws take priority over the above mentioned requirements. If in doubt, consult your local representative or the technical service department.
- No modification of this equipment is allowed.



CAUTIONS

A **caution** explains special measures for the safe and effective use of the device.

- When using accessories, read the manufacturer's User Manual. For consumables important information can be provided on the packaging, see also symbols on page 34.
- At low pressures, the flow through the mask vent holes may be inadequate to clear all exhaled gas, and some rebreathing may occur.
- The device may not be exposed to excessive force.
- If the device should fall accidentally on the ground, please contact your authorised service agent.

¹ Ports may be incorporated into the mask or in connectors that are near the mask.

² During partial (below rated minimum voltage) or total power failure, therapy pressures will not be delivered. When power is restored, operation can proceed with no change to settings.

- Pay attention to leaks and other unusual sounds. If there is a problem, contact an authorised service agent.
- Do not replace any parts in the breathing circuit while the device is in operation. Stop operation before changing parts.

Notes:

A note advises to special product features.

- *The above are general warnings and cautions. Further specific warnings, cautions and notes appear next to the relevant instructions in the user guide.*
- *Only trained and authorised personnel are allowed to make clinical setting changes.*
- *Position the device ensuring the power cord can be easily removed from the power outlet.*

Limited warranty

ResMed Pty Ltd (hereafter 'ResMed') warrants that your ResMed product shall be free from defects in material and workmanship from the date of purchase for the period specified below.

Product	Warranty period
<ul style="list-style-type: none"> • Mask systems (including mask frame, cushion, headgear and tubing)—excluding single-use devices • Accessories—excluding single-use devices • Flex-type finger pulse sensors • Humidifier water tubs 	90 days
<ul style="list-style-type: none"> • Batteries for use in ResMed internal and external battery systems 	6 months
<ul style="list-style-type: none"> • Clip-type finger pulse sensors • CPAP and bilevel device data modules • Oximeters and CPAP and bilevel device oximeter adapters • Humidifiers and humidifier cleanable water tubs • Titration control devices 	1 year
<ul style="list-style-type: none"> • CPAP, bilevel and ventilation devices (including external power supply units) • Battery accessories • Portable diagnostic/screening devices 	2 years

This warranty is only available to the initial consumer. It is not transferable.

If the product fails under conditions of normal use, ResMed will repair or replace, at its option, the defective product or any of its components.

This limited warranty does not cover: a) any damage caused as a result of improper use, abuse, modification or alteration of the product; b) repairs carried out by any service organization that has not been expressly authorized by ResMed to perform such repairs; c) any damage or contamination due to cigarette, pipe, cigar or other smoke; and d) any damage caused by water being spilled on or into an electronic device.

Warranty is void on product sold, or resold, outside the region of original purchase.

Warranty claims on defective product must be made by the initial consumer at the point of purchase.

This warranty replaces all other expressed or implied warranties, including any implied warranty of merchantability or fitness for a particular purpose. Some regions or states do not allow limitations on how long an implied warranty lasts, so the above limitation may not apply to you.

ResMed shall not be responsible for any incidental or consequential damages claimed to have resulted from the sale, installation or use of any ResMed product. Some regions or states do not allow the exclusion or limitation of incidental or consequential damages, so the above limitation may not apply to you.

This warranty gives you specific legal rights, and you may also have other rights which vary from region to region. For further information on your warranty rights, contact your local ResMed dealer or ResMed office.

R001-325/2 09 09



ResMed Pty Ltd

MANUFACTURER 1 Elizabeth Macarthur Drive Bella Vista NSW 2153 Australia

See Resmed.com for other ResMed locations worldwide. ResMed, SlimLine, SmartStart, Stellar and TiCONTROL are trademarks of the ResMed family of companies. For patent and other intellectual property information, see ResMed.com/ip
© 2018 ResMed 248933/1 2018-04



ResMed.com